

Southwark Metal Mfg. Co. Philadelphia Division

PRODUCT CATEGORY INDEX

PAGE	DESCRIPTION
4	Snaplock Pipe
5	Elbows, Angles, & Register Boots
6-7	Trunk Duct & Fittings
8-9	Trunk Duct Fittings & Installation Accessories
10-11	Oval Pipe & Fittings
12-13	Wall Stack & Fittings
14-15	Sheet Metal & Fiberglass Takeoffs
16	Sheet Metal & Fiberglass Collars
17	Air-Tite Takeoffs
18-19	Accessories
20-21	Ceiling Outlets & Register Boxes
22	Venting Products
23	Black Pipe, Elbows, & Accessories

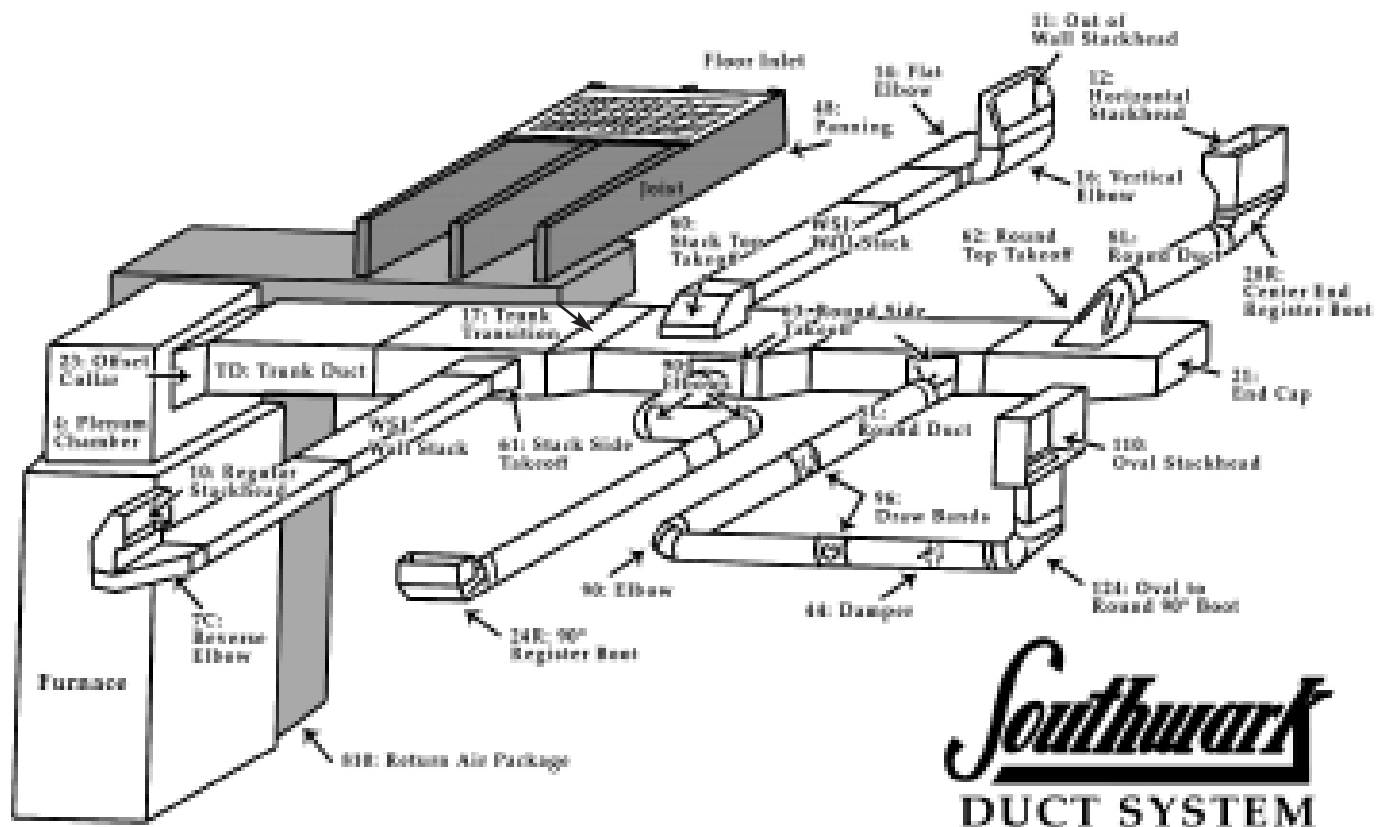

Southwark
DUCT SYSTEM

Table of Contents

PRODUCT NUMBER INDEX

Item No.	Product Name	Page	Item No.	Product Name	Page	Item No.	Product Name	Page
3	Fiberglass Extension	9	77WF	Diffuser Funnel w/Flange	21	812B	Cold Air Boot	8
4	Plenum Chamber	8	78	Wye Branch	19	813	Return Air Package	8
5	12" Duct Hanger	9	83PC	Branch Connector	19	813B	Cold Air Boot	8
6	S-Cleat	9	84ST	Ductboard Collar	16	814	Return Air Package	8
8	Drive Cleat	9	84STWD	Ductboard Collar w/Damper	16	814B	Cold Air Boot	8
13	Flat Trunk 45° Angle	6	85	Insul.Ceiling Box Top Outlet	20	815	Return Air Package	8
14	Flat Trunk 90° Elbow	6	85S	Insul.Ceiling Box Side Outlet	20	815B	Cold Air Boot	8
14TT	Trunk Tee	7	86SC	Sleeve Connector	19	816	Return Air Package	8
15	Vertical Trunk 45° Angle	6	87	Lever Takeoff Metal	14	816B	Cold Air Boot	8
16	Vertical Trunk 90° Elbow	6	90	90° Adjustable Elbow	5	817	Return Air Package	8
17	Trunk Transition	6	90	Floor Register Box- 6" Deep	21	817B	Cold Air Boot	8
17CR	Adjustable Register Boot	5	91	Floor Reg. Box- 11" Deep	21	AT62	Air-Tite Top Takeoff	17
17TT	Trunk Tee	7	92	Funnel Register Box	21	AT62WD	Air-Tite Top w/Damper	17
18	Connector- Plenum to Trunk	7	93	Elbow Draft Vent	18	AT63	Air-Tite Side Takeoff	17
19RC	Register Collar	21	94	Horizontal Draft Vent	18	AT63A	Air-Tite Adj. Takeoff	17
20	Trunk Straight Collar	6	95	Vertical Draft Vent	18	AT63WD	Air-Tite Side w/Damper	17
21	Trunk End Cap	7	96	Drawband - Gear Clamp	19	ATD	Air-Tite w/Damper	17
23	Trunk Offset Collar	6	97	Flat Collar	16	ATDBM	Air-Tite Bellmouth w/Damper	17
23AT	Trunk Transition Collar	7	97FG	Spin Collar Fiberglass	16	ATDRP	Air-Tite Rd Pipe w/Damper	17
24	90° Stack Boot	12	97FGWD	Spin Collar w/Damper Fiberglass	16	ATHE	Air-Tite High Efficiency	17
24R	90° Register Boot	5	97LS	Long Style Flat Collar	16	ATHEWD	Air-Tite High Efficiency w/Damper	17
24RWE	90° Basement Boot	5	97LSWD	Flat Collar w/Damper	16	ATS	Air-Tite w/Scoop	17
26	Angle Stack Boot	12	98	Spin Collar w/Scoop Fiberglass	16	ATSD	Air-Tite w/Scoop & Damper	17
26R	45° Register Boot	5	98WD	Spin Collar w/Scoop & Damper Fiberglass	16	ATT	Air-Tite Plain	17
27	Straight Stack Boot	12	99	Chimney Cap	18	ATTBM	Air-Tite Bellmouth	17
27R	Straight Register Boot	5	99LD	Chimney Cap- Lo Draft	18	ATTRP	Air-Tite Round Pipe	17
28	End Stack Boot	12	100	Oval Pipe - 100"	10	ATTRP45	Air-Tite 45° Saddle	17
28R	End Register Boot	5	106	Rd to Oval Reverse Boot	10	BP12	Black Pipe- 12"	23
28RL	End Register Boot-Left	5	110	Oval Stackhead	10	BP24	Black Pipe- 24"	23
28RR	End Register Boot-Right	5	111	Register Outlet	10	BP36	Black Pipe- 36"	23
29RO	Offset Register Boot	5	113	Flat Oval 45° Angle	10	BP54	Black Tee Joint	23
31	Return Air Frame	9	114	Flat Oval 90° Elbow	10	BP55	Black Tee Cap	23
31PF	Plaster Frame	21	115	Vertical Oval 45° Angle	11	BP58	Black Reducer- 3PC	23
34PLF	Adj. Takeoff Fiberglass	15	116	Vertical Oval 90° Elbow	11	BP90	Black 90° Elbow	23
35	Trunk Reducer	9	117	Flue Thimble	18	BP96	Black Drawband	23
35A	Trunk Reducer	9	120SC	Snap Collar - Sheet Metal	16	BP127	Black Oval to Rd Adapter	23
36	Fresh Air Intake	19	122SC	Snap Collar - Fiberglass	16	BPC	Black Pipe Collar	23
37	Rigid S-Cleat	9	124	Rd to Oval 90° Boot	11	BPCHAD	Black Chimney Adapter	23
39	Galvanized Vent Hood	19	124R	Oval 90° Register Boot	10	BPCON	Black Connector	23
39AL	Alum Wall Cap w/Damper	22	127	Rd to Oval Straight Boot	11	BPTC	Black Trim Collar	23
39GP	Gray Plastic Wall Cap	22	127R	Oval Straight Reg. Boot	10	CAF	Cold Air Frame	9
39WP	White Plastic Wall Cap	22	128	Oval to Oval Reverse Boot	11	CID	Cast Iron Damper	23
40	Damper Section	16	128R	Oval End Register Boot	10	EV141	Eave Vent	22
42	Trunk Volume Damper	7	132	'A' Adapter	13	HT15	Rd to Rd 1/2 Tab Takeoff Metal	14
44	Round Damper	18	133	'B' Adapter	13	MF	Aluminum Flexible Duct	22
44S	Rd Damper- Fixed Hardware	19	137	Drain Pan	21	MR	Mounting Rails	20
45	45° Adjustable Angle	5	140	Adjustable Roof Flashing	19	PC	Plenum Corner	9
47	Connector- Furnace to Plenum	7	141	Tall Cone Flashing	19	RV51	Alum Roof Cap-8" opening	22
48	Panning Material	9	142	Storm Collar	19	SAL	Aluminum Transition Duct	22
49P	Adjustable Plenum Panel	8	150	Oval Stackhead w/Collar	10	S5	Pivot Takeoff Metal	15
49T	Adjustable Plenum Top	8	156	Spin Collar	16	S75	Drawband - Snap	19
50	Wye - 15" Long	18	156D	Spin Collar w/Damper	16	SAE	Aluminum Elbow	22
51	Wye - 24" Long	18	156S	Spin Collar w/Scoop	16	SAP	Aluminum Pipe	22
51F	Ceiling Box	20	156SD	Spin Collar w/Scoop & Damper	16	SB30	Return Air Support Box	9
52	Flue Wye	18	160	Oval Pipe - 60"	10	SB38	Return Air Support Box	9
53	Tee- 24" Long	18	162	Oval Top Takeoff	11	SH	White Flexible Vinyl Hose	22
54	Tee- 15" Long	18	163	Oval Side Takeoff	11	SL24	Round Pipe-24"	4
54SW	Swivel Tee	18	170	Return Air Pan	21	SL60	Round Pipe-60"	4
55	Tee Cap	19	177	Ceiling Outlet	20	SL120	Round Pipe-120"	4
58	Reducer- 3PC	18	177S	Ceiling Side Outlet	20	SPC	Pipe Clamp	22
58WF	Diffuser Outlet w/Flange	21	199	H-Vent	18	SVH	Aluminum Vent Hood	22
59F	Ceiling Box	20	201VH	Aluminum Wall Vent	22	SVHBP	Brown Plastic Vent Hood	22
62	Top Takeoff Metal	14	201VHP	White Plastic Vent	22	SVHWP	White Plastic Vent Hood	22
62FG	Top Takeoff Fiberglass	14	207	Quick Tee 90°	19	TD	Trunk Duct	6
63	Side Takeoff Metal	14	208	Quick Y 45°	19	WSJ	Wallstack	12
63A	Adjustable Takeoff Metal	15	220EC	Eave Vent	22	WS7C	Center Reverse Stack Elbow	13
63AFG	Adj. Takeoff Fiberglass	15	239	Alum Roof Cap w/Damper	22	WS9	Double Stackhead	12
63FG	Side Takeoff Fiberglass	15	240	Alum Roof Cap w/Damper	22	WS10	Stackhead	12
64	Double Top Takeoff Metal	15	241	Alum Roof Cap w/Damper	22	WS10X	Stackhead w/Ears	12
65	Rd to Rd Adj. Takeoff Metal	14	277	Ceiling Outlet No Flange	20	WS11	Projection Stackhead	12
66WF	Ceiling Diffuser Outlet	21	355	Oval Straight Register Box	11	WS12	Horizontal Stackhead	12
67	Basement Diffuser Box	20	360	Oval Angle Register Box	11	WS13	Flat Stack 45° Angle	13
70	Register Takeoff	20	390WP	White Louver Hood w/Tail	22	WS14	Flat Stack 90° Elbow	13
71	Register Tee	20	391WP	White Louver Hood	22	WS15	Vertical Stack 45° Angle	13
72	Diffuser Tee	21	582	Reducer- 2PC	19	WS16	Vertical Stack 90° Elbow	13
72WF	Diffuser Tee w/Flange	21	810	Return Air Package	8	WS17	Stack Transition	13
73	Square Diffuser Box	21	810B	Cold Air Boot	8	WS20	Stack Straight Collar	13
74	Register Cap	20	811	Return Air Package	8	WS21	Stack End Cap	13
75	Register Box- 7" Deep	20	811B	Cold Air Boot	8	WS45	Stack Damper	13
77	Rd to Square Diffuser Box	20	812	Return Air Package	8	WS60	Stack Top Takeoff	13
77S	Rd to Square Diffuser Box Side	20				WS61	Stack Side Takeoff	13

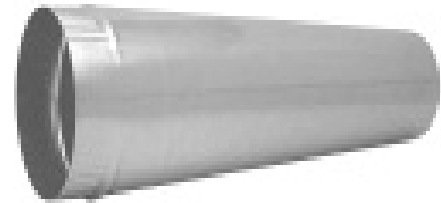

No. SL24
2 FT PIPE - 30, 26 & 24 GAUGE

No tools required to assemble Snaplock Pipe. Simply start at one end and easily snap pipe together. One person can quickly assemble up to 10 ft. lengths.

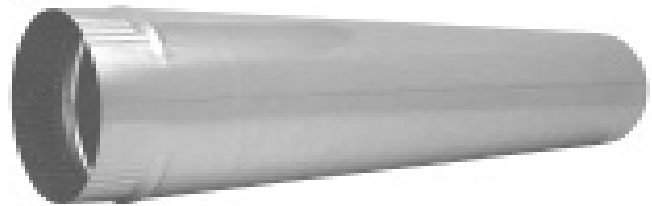

No. SL60
5 FT PIPE - 30 & 26 GAUGE

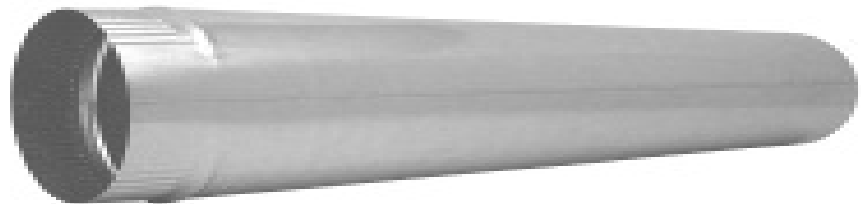

No. SL120
10 FT PIPE - 30 GAUGE

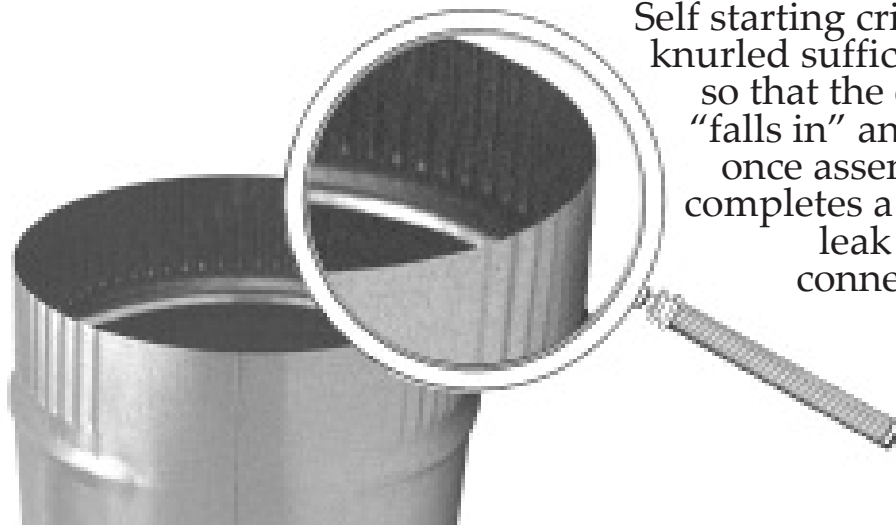

Self starting crimp is knurled sufficiently so that the crimp "falls in" and yet, once assembled completes a rigid, leak proof connection.



90° ADJUSTABLE ELBOW



45° ADJUSTABLE ANGLE



No. 24R
90° REGISTER BOOT



No. 27R
STRAIGHT
REGISTER BOOT

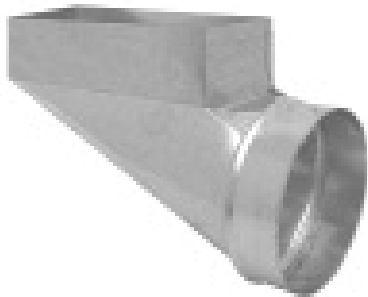

No. 28R
END REGISTER BOOT
No. 28RL LEFT HAND
No. 28RR RIGHT HAND



No. 29RO
2" OFFSET
REGISTER BOOT



No. 17CR
OFFSET
ADJUSTABLE
REGISTER BOOT



No. 26R
45° ANGLE
REGISTER BOOT

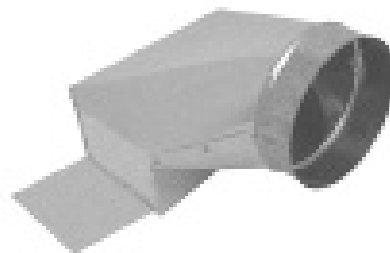

No. 24RWE
90° BASEMENT BOOT

- 12", 30", 48", 60", and 96" Lengths
- Furnished in Button Snaplock with S-Cleat & Drive Connections
- Cross Broken for Extra Stiffening Strength



No. TD
TRUNK DUCT



No. 13
FLAT 45° ANGLE

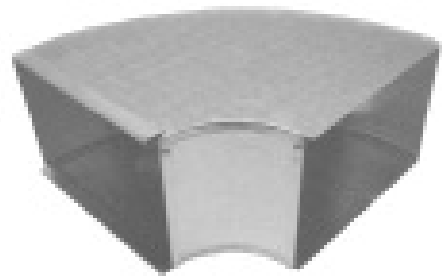

No. 14
FLAT 90° ELBOW

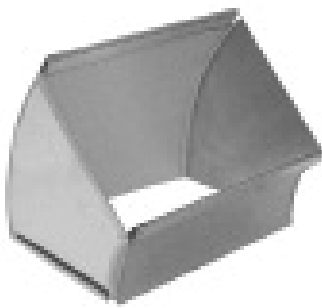

No. 15
VERTICAL 45° ANGLE



No. 16
VERTICAL 90° ELBOW

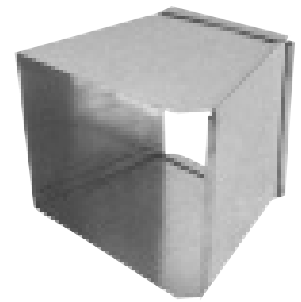

No. 17
TRANSITION

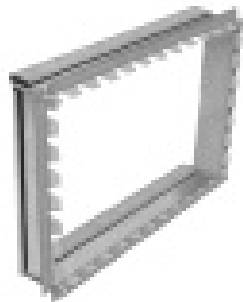

No. 20
STRAIGHT COLLAR

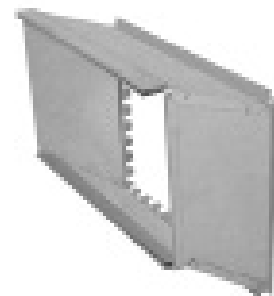

No. 23
OFFSET COLLAR



No. 21
END CAP

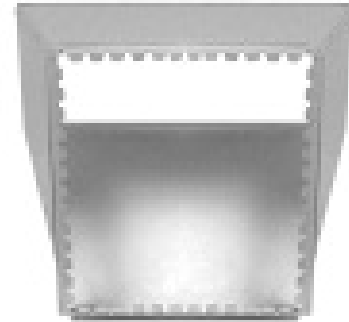

No. 23AT
TRANSITION COLLAR

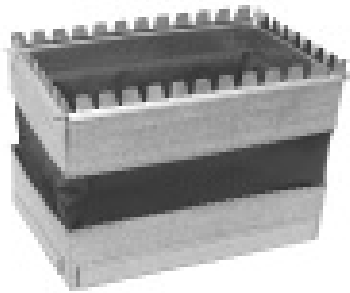

No. 18
CONNECTOR
PLENUM to TRUNK



No. 47
CONNECTOR
FURNACE to PLENUM

23AT TRANSITION	
PLENUM OPENING (width x height)	DUCT SIZE
12x10	14x8
12x11	16x8
12x12	18x8
12x14	20x8
12x15	22x8
12x16	24x8
14x15	26x8
14x16	28x8
16x15	30x8
16x16	32x8

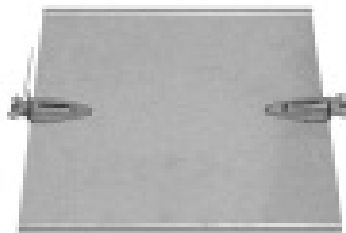

No. 42
VOLUME DAMPER

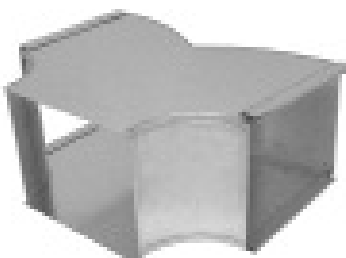

No. 14TT
TRUNK TEE

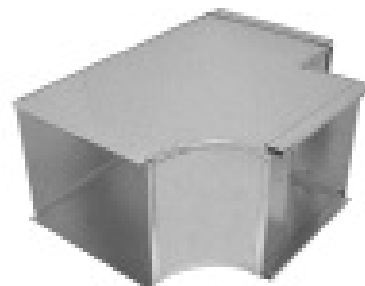

No. 17TT
TRUNK TEE

No. 49T
ADJ. PLENUM TOP



No. 49P
ADJ. PLENUM SIDE



COLD
AIR
BOOT

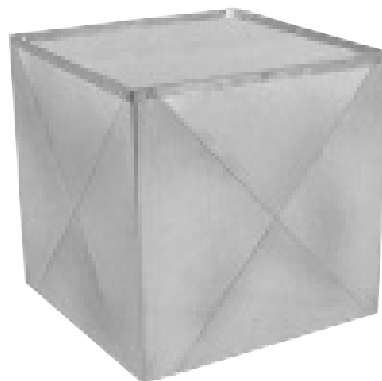

No. 4
PLENUM CHAMBER
CUSTOM SIZES
SHIPPED KNOCKED
DOWN OR MADE-UP

ADJUSTABLE PLENUMS

AVAILABLE TO ORDER
(Actual plenum height,
2" less than listed size)

TO INSTALL...

- (1) Cut raw edges of side panels to desired width and height sizes.
- (2) Trim top to desired width and depth dimensions.
- (3) Assemble 3 sides, slide top into side panel pockets, then position fourth side.
- (4) Secure assembly with sheet metal screws.

RETURN AIR PACKAGE

Complete package
consisting of:

- 1 - #20 Starting Collar
 - 2 - 30" Duct Sections
 - 1 - R.A. Plenum with
1" Filter Rack
 - 6 - 10" Drive Straps
- Shipped K.D. in One Carton*

RA PKG.	DUCT SIZE	BOOT ONLY
810	20x10 - 20x16	810B
811	25x10 - 25x16	811B
812	20x10 - 20x14	812B
813	25x10 - 25x14	813B
814	20x8 - 20x16	814B
815	24x8 - 24x16	815B
816	20x8 - 20x14	816B
817	24x8 - 24x14	817B

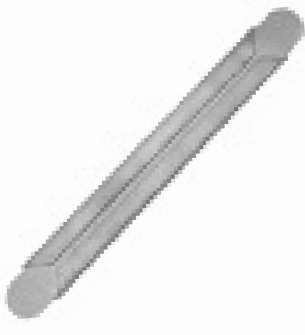

No. 8
DRIVE CLEAT

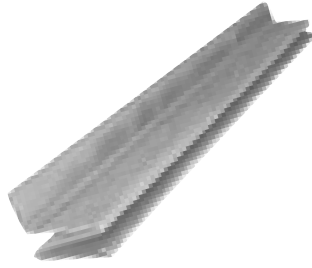

No. 37
RIGID S-CLEAT



No. 6
S-CLEAT

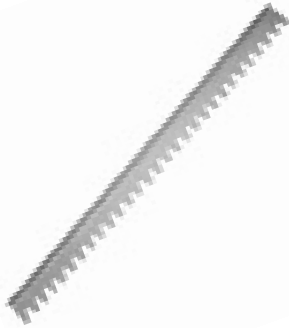

No. 3
FIBERGLASS
EXTENSION

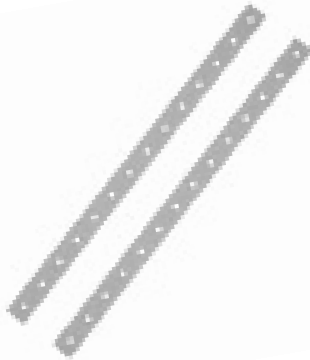

No. 5
12" DUCT HANGER

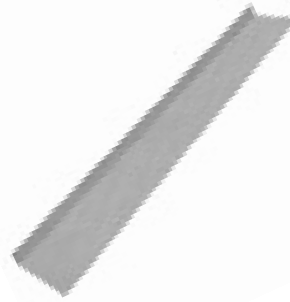

No. CAF
COLD AIR FRAME



No. PC
PLENUM
CORNER



No. 48
PANNING
MATERIAL

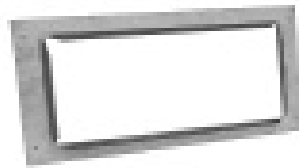

No. 31
RETURN AIR
FRAME

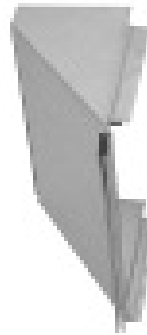

No. 35
TRUNK REDUCER



No. 35A
TRUNK REDUCER

RETURN AIR/SUPPORT BOX

	SB30	SB38
A DIMENSION	30"	38"
B DIMENSION	20"	26"
RETURN AIR DUCT SIZE	8 X 24	10 X 25

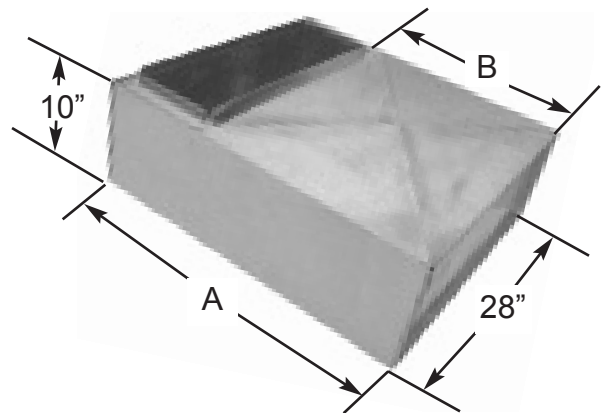

RETURN AIR/SUPPORT BOX

No. SBF - Return Air Support Box w/Filter Rack
(Accepts 1", 4", & 5" Filter)

No. 100 OVAL PIPE 100" - 30 Ga.

No. 112 OVAL PIPE 112" - 30 Ga.

No. 160 OVAL PIPE 60" - 30 Ga.

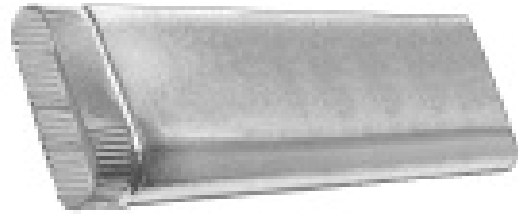

No. 110
OVAL STACKHEAD



No. 113
FLAT 45° ANGLE



No. 114
FLAT 90° ELBOW

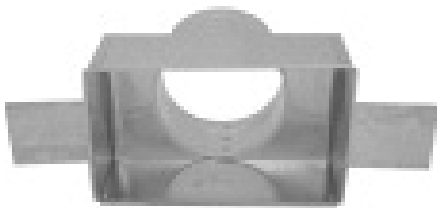

No. 111
REGISTER OUTLET



No. 150
STACKHEAD w/COLLAR



No. 106
OVAL to ROUND
REVERSE BOOT



No. 124R
90° REGISTER BOOT



No. 127R
STRAIGHT
REGISTER BOOT

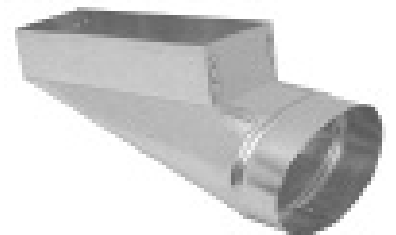

No. 128R
END REGISTER BOOT

WALL STACK VS. OVAL PHYSICAL COMPARISON

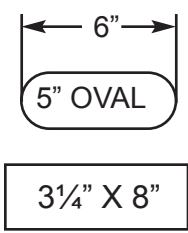
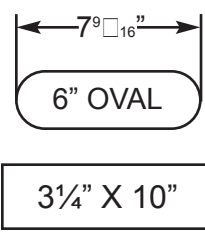
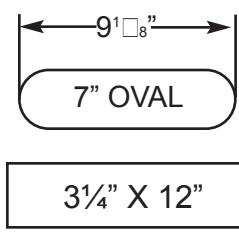
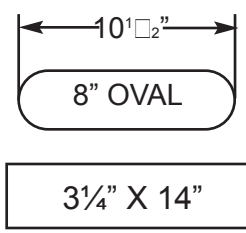
 <p>5" OVAL</p> <p>3 1/4" X 8"</p>	 <p>6" OVAL</p> <p>3 1/4" X 10"</p>	 <p>7" OVAL</p> <p>3 1/4" X 12"</p>	 <p>8" OVAL</p> <p>3 1/4" X 14"</p>
---	--	---	--

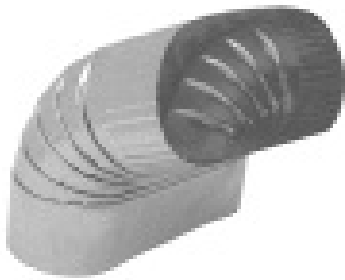

No. 115
VERTICAL 45° ANGLE

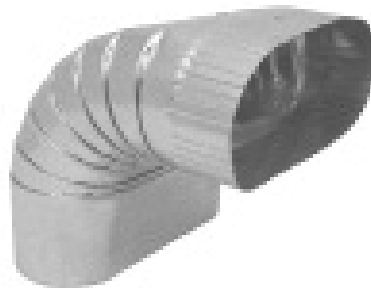

No. 116
VERTICAL 90° ELBOW



No. 162
OVAL TOP TAKEOFF



No. 127
OVAL to ROUND
STRAIGHT BOOT



No. 124
OVAL to ROUND
90° BOOT



No. 163
OVAL SIDE TAKEOFF



No. 128
OVAL to OVAL
REVERSE BOOT



No. 355
STRAIGHT OVAL
REGISTER BOX

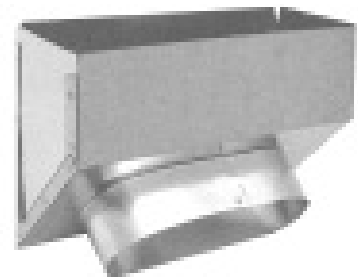

No. 360
ANGLE OVAL
REGISTER BOX

- 12", 24", 30", 60" & 100" Lengths
- Furnished in Button Snaplock
- Two Pieces Per Section
- No Tools and No Indentations, Just Snap It and It's Closed

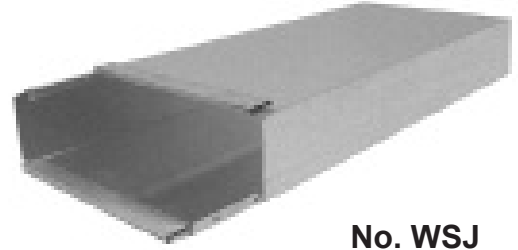

No. WSJ
WALL STACK



No. 24
90°
STACK BOOT

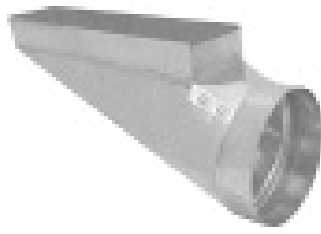

No. 28
END
STACK BOOT



No. 26
ANGLE
STACK BOOT



No. 27
STRAIGHT
STACK BOOT

STACKHEADS



No. WS9
DOUBLE
STACKHEAD

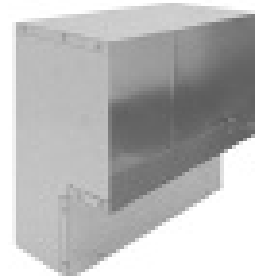

No. WS10
STACKHEAD

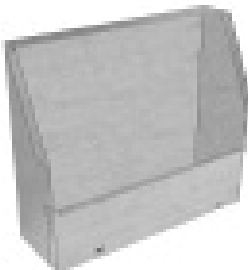

No. WS11
PROJECTION
STACKHEAD

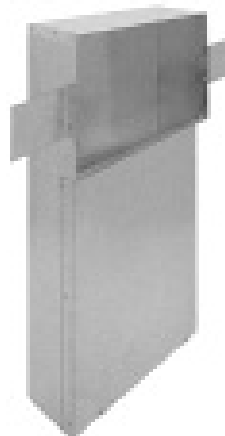

No. WS10X
STACKHEAD w/EARS

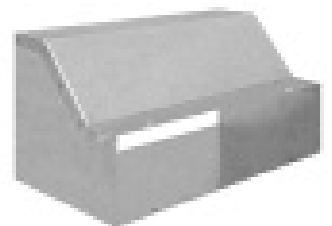

No. WS12
HORIZONTAL
STACKHEAD



No. WS13
FLAT 45° ANGLE

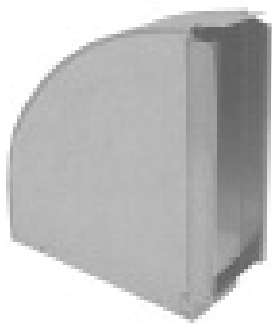

No. WS14
FLAT 90° ELBOW

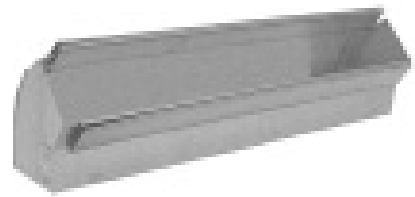

No. WS15
VERTICAL 45° ANGLE

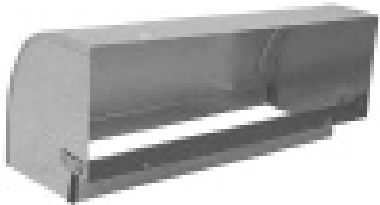

No. WS16
VERTICAL 90°
ELBOW

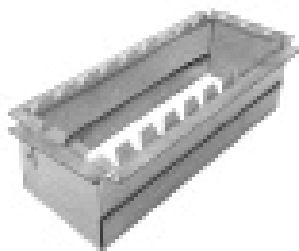

No. WS20
STRAIGHT COLLAR



No. WS21
END CAP



No. WS45
DAMPER



No. WS7C
CENTER
REVERSE ELBOW
WS7L - Left Hand
WS7R - Right Hand



No. WS17
TRANSITION

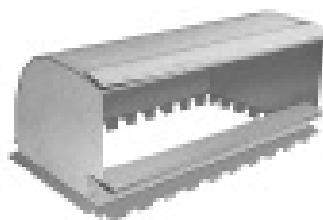

No. WS60
TOP TAKEOFF

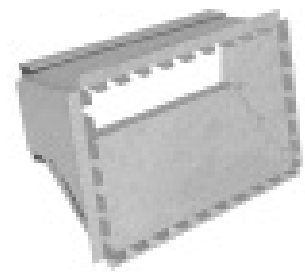

No. WS61
SIDE TAKEOFF

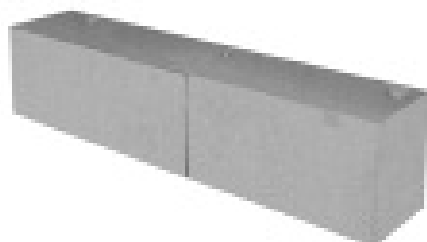

No. 132
"A" ADAPTER ADJUSTABLE
2 1/4 x 10 - 12 or 14



No. 133
"B" ADAPTER ADJUSTABLE
4 x 10 - 3 1/4 x 10, 12, or 14

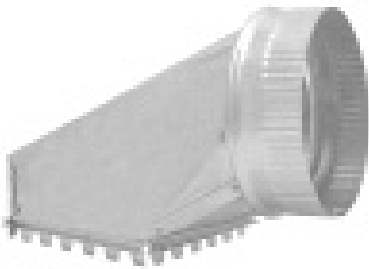

No. 62
SHEET METAL
TOP TAKEOFF

Pipe Size	Base Opening
4"	4 x 6
5"	5 x 6
6"	6 x 6
7"	7 x 7
8"	8 x 8
9"	10 x 10
10"	11 ¹ / ₂ x 10
12"	12 x 12
14"	14 x 14

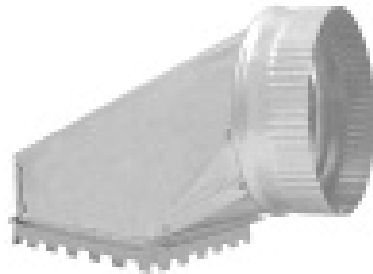

No. 62FG
FIBERGLASS TOP
TAKEOFF

Pipe Size	Base Opening
4"	4 x 6
5"	5 x 6
6"	6 x 6
7"	7 x 7
8"	8 x 8
9"	10 x 10
10"	11 ¹ / ₂ x 10
12"	12 x 12
14"	14 x 14

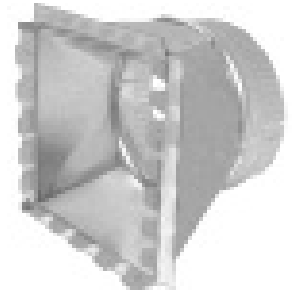

No. 63
SHEET METAL
SIDE RD TAKEOFF

Pipe Size	Base Opening
4"	6 x 6
5"	6 x 6
6"	6 x 6
7"	6 x 8
8"	6 x 10
9"	7 x 12
10"	7 x 14
12"	8 x 18
14"	8 x 20

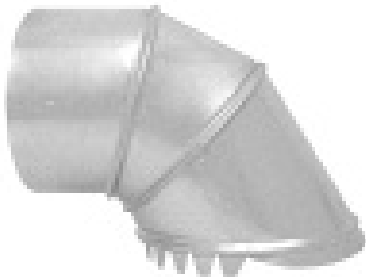

No. HT15
SHEET METAL RD to RD
HALF TAB TAKEOFF

Pipe Size	Base Opening
6"	7"



No. 65
SHEET METAL RD to RD
ADJUSTABLE TAKEOFF

Pipe Size	Base Opening
5"	6"
6"	7"
7"	8"
8"	9"



No. 87
SHEET METAL
LEVER TAKEOFF

Pipe Size	Base Opening
5"	6"
6"	7"
7"	8"



No. 63FG
FIBERGLASS
SIDE TAKEOFF

Pipe Size	Base Opening
4"	6 x 6
5"	6 x 6
6"	6 x 6
7"	6 x 8
8"	6 x 10
9"	7 x 12
10"	7 x 14
12"	8 x 18
14"	8 x 20



No. 63A
SHEET METAL
ADJUSTABLE RD TAKEOFF

Pipe Size	Base Opening
4"	4 x 6
5"	5 x 6
6"	6 x 7
7"	7 x 8
8"	7 x 10
9"	9 x 11
10"	10 x 12
12"	12 x 16
14"	14 x 19



No. 63AFG
FIBERGLASS
ADJUSTABLE TAKEOFF

Pipe Size	Base Opening
4"	4 x 6
5"	5 x 6
6"	6 x 7
7"	7 x 8
8"	7 x 10
9"	9 x 11
10"	10 x 12
12"	12 x 16
14"	14 x 19



No. S5
SHEET METAL
PIVOT TAKEOFF

Pipe Size	Base Opening
5"	6"
6"	7"
7"	8"

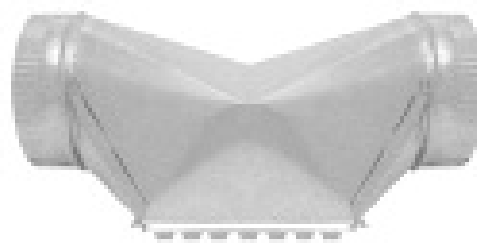

No. 64
SHEET METAL
DOUBLE TOP TAKEOFF

Pipe Size	Base Opening
5"	6 x 10
6"	7 x 10
7"	7 x 14
8"	8 x 14



No. 34PLF
FIBERGLASS
ADJUSTABLE TAKEOFF

Pipe Size	Base Opening
5"	5 x 6
6"	6 ³ / ₈ x 6 ³ / ₈
7"	7 x 8
8"	6 ³ / ₈ x 10

SHEET METAL COLLARS



No. 120SC
SNAP COLLAR

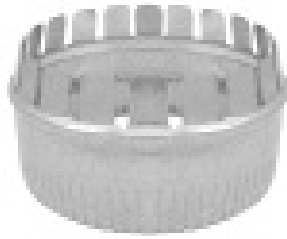

No. 97
FLAT COLLAR



No. 97LS
LONG FLAT COLLAR
No. 97LSWD
COLLAR w/DAMPER



No. 40
DAMPER SECTION



No. 156
SPIN FITTING



No. 156D
SPIN FITTING
w/DAMPER



No. 156S
SPIN FITTING
w/SCOOP



No. 156SD
SPIN FITTING
w/SCOOP &
DAMPER

FIBERGLASS COLLARS



No. 84ST
COLLAR
No. 84STWD
COLLAR w/DAMPER



No. 122SC
SNAP COLLAR



No. 97FG
SPIN COLLAR



No. 97FGWD
SPIN COLLAR
w/DAMPER



No. 98
SPIN COLLAR
w/SCOOP



No. 98WD
SPIN COLLAR
w/SCOOP &
DAMPER



No. ATT
TAKEOFF
PLAIN



No. ATD
TAKEOFF
w/DAMPER



No. ATS
TAKEOFF
w/SCOOP

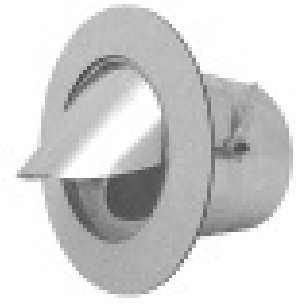

No. ATSD
TAKEOFF
w/SCOOP &
DAMPER



No. ATTRP
RD PIPE TAKEOFF
No. ATDRP
w/DAMPER



No. ATTRP45
45° SADDLE
TAKEOFF



No. ATTBM
BELLMOUTH TAKEOFF
No. ATDBM
w/DAMPER



No. AT62
TOP TAKEOFF
No. AT62WD
w/DAMPER



No. AT63
RECTANGULAR TAKEOFF
No. AT63WD
w/DAMPER



No. ATHE
HIGH EFFICIENCY TAKEOFF
No. ATHEWD
w/DAMPER



No. AT63A
ADJUSTABLE
RD TAKEOFF

Size	Base Opening
4"	6 x 6
5"	6 x 6
6"	6 x 6
7"	6 x 8
8"	6 x 10
9"	7 x 12
10"	7 x 14
12"	8 x 18
14"	8 x 20

Size	Base Opening
5"	6 x 10
6"	6 x 10
7"	6 x 10
8"	8 x 12
9"	9 x 12
10"	10 x 14
12"	12 x 18
14"	14 x 18

- Tees and Wyes
- Reducers
- Dampers
- Vents
- Drawbands
- Flashing
- Connectors

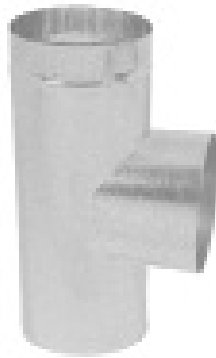

TEE JOINT
No. 53 24" LONG
No. 54 15" LONG



SMOKE Y
No. 50 15" LONG
No. 51 24" LONG



No. 52
FLUE Y



No. 54SW
SWIVEL TEE



No. 58
3 Pc. REDUCER
 Available Crimped



No. 99
CHIMNEY CAP



No. 99LD
LO-DRAFT
CHIMNEY CAP



No. 199
"H" VENT



No. 117
FLUE THIMBLE



No. 93
ELBOW
DRAFT VENT



No. 94
HORIZONTAL
DRAFT VENT



No. 95
VERTICAL
DRAFT VENT

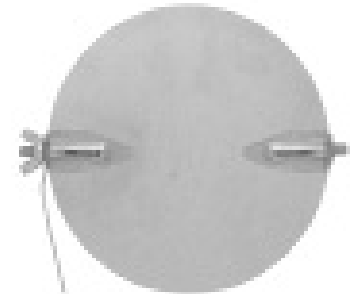

No. 44
ROUND DAMPER



No. 55
TEE CAP
Available Crimped
Available w/Handle



No. 207QT
QUICK TEE 90°



No. 208QY
QUICK Y 45°



No. 582
2 Pc. REDUCER



No. 78
Y-BRANCH

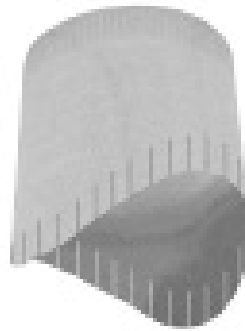

No. 83PC
BRANCH
CONNECTOR



No. 86SC
SLEEVE
CONNECTOR

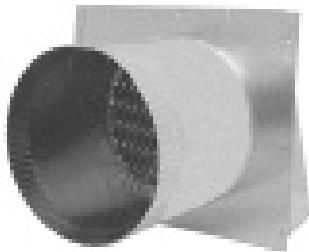

No. 36
FRESH AIR INTAKE

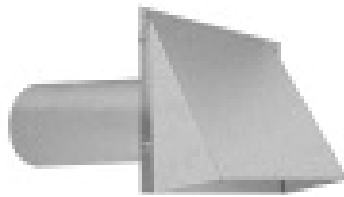

No. 39
GALVANIZED
VENT HOOD

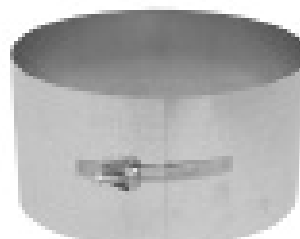

No. 96
DRAWBAND
GEAR CLAMP



No. S75
SNAPPY
DRAWBAND

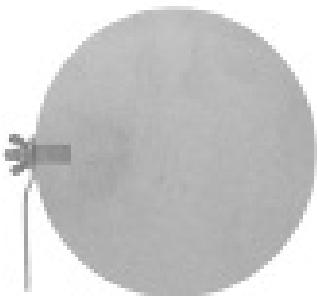

No. 44S
ROUND DAMPER
FIXED HARDWARE

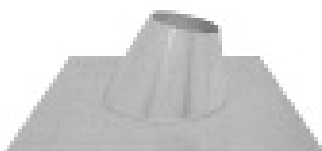

No. 140
ADJ. ROOF
FLASHING

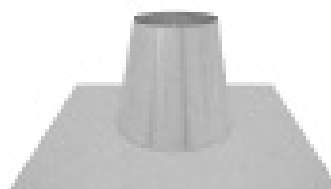

No. 141
TALL CONE
FLASHING



No. 142
STORM COLLAR

Ceiling Outlets & Register Boxes



No. 177
CEILING OUTLET

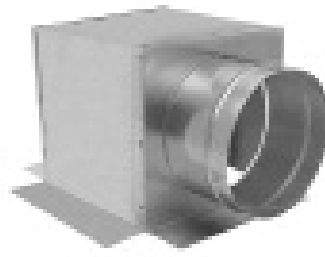

No. 177S
SIDE OUTLET



No. 277
CEILING OUTLET
NO FLANGE



No. 77
ROUND to SQUARE
DIFFUSER BOX



No. 77S
ROUND to SQUARE
DIFFUSER BOX
SIDE OUTLET

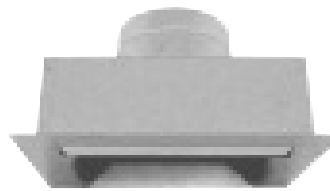

No. 85
INSULATED CEILING
BOX TOP OUTLET

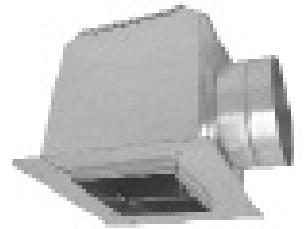

No. 85S
INSULATED CEILING
BOX SIDE OUTLET



No. 51F
STRAIGHT CEILING BOX
w/FLANGE



No. 59F
90° CEILING BOX
w/FLANGE

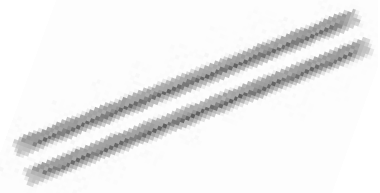

No. MR
MOUNTING RAILS
Available 24" or 36" long

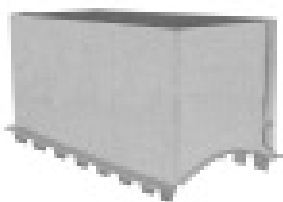

No. 70
REGISTER TAKEOFF

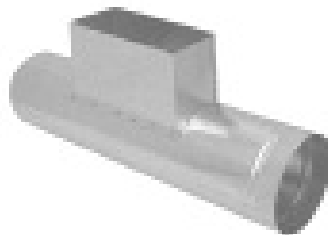

No. 71
REGISTER TEE



No. 74
REGISTER CAP



No. 75
7" DEEP
REGISTER BOX

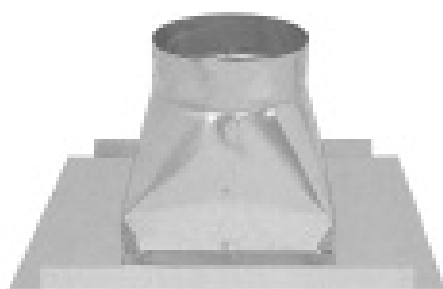

No. 77WF
DIFFUSER FUNNEL
w/FLANGE

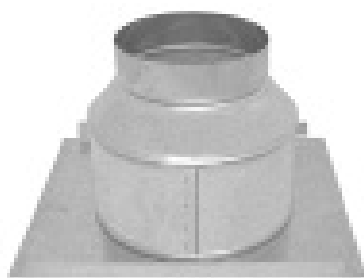

No. 58WF
DIFFUSER OUTLET
w/FLANGE

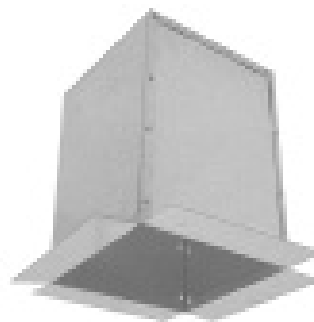

No. 73
SQUARE
DIFFUSER BOX

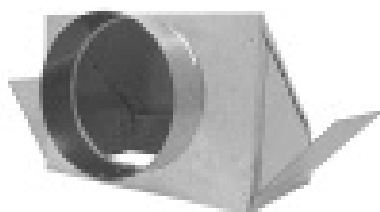

No. 67
BASEMENT
DIFFUSER BOX



No. 72
DIFFUSER TEE

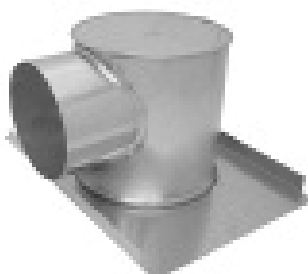

No. 72WF
DIFFUSER TEE
w/FLANGE

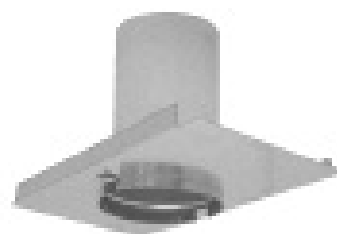

No. 66WF
CEILING DIFFUSER
OUTLET



No. 19RC
REGISTER COLLAR



No. 92
FUNNEL
REGISTER BOX
w/FLANGE



No. 90
FLOOR REGISTER
BOX 6" DEEP



No. 91
FLOOR REGISTER
BOX 11" DEEP



No. 137
DRAIN PAN

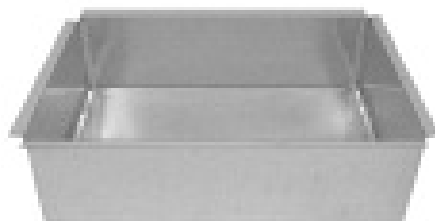

No. 170
RETURN AIR PAN

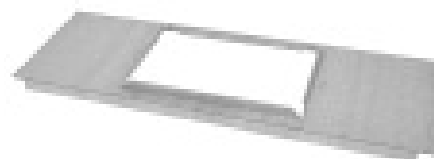

No. 31PF
PLASTER FRAME



No. SVH
ALUMINUM
VENT HOOD
No. SVHBP
BROWN PLASTIC
No. SVHWP
WHITE PLASTIC

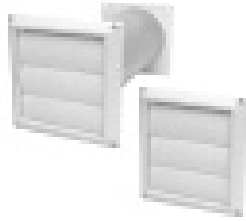

No. 390WP
WHITE LOUVER
HOOD w/TAIL
No. 391WP
FACE ONLY



No. SAP
ALUMINUM PIPE



No. SAE
ALUMINUM
ELBOW



No. SPC
PIPE CLAMP



No. SH
FLEXIBLE
WHITE VINYL HOSE



No. MF
FLEXIBLE
ALUMINUM DUCT



No. SAL
ALUMINUM
TRANSITION DUCT

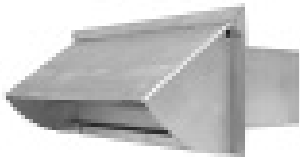

No. 201VH
ALUMINUM
WALL CAP
No. 201VHWP
WHITE PLASTIC

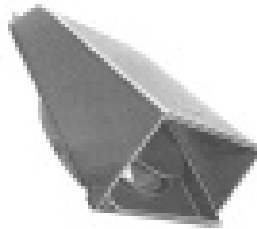

No. 39GP
GRAY PLASTIC
WALL CAP
w/DAMPER
No. 39WP
WHITE PLASTIC



No. 39AL
ALUMINUM
WALL CAP
w/DAMPER

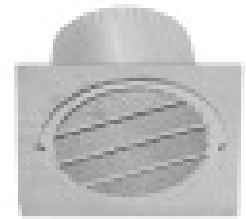

No. EV141
EAVE VENT



No. RV51
ALUMINUM ROOF
CAP w/SCREEN
UP TO 8" ROUND

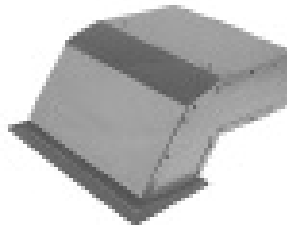

No. 220EC
EAVE VENT
w/GRILLE



ALUMINUM ROOF
CAP w/DAMPER
& SCREEN

No. 239 - Fits 4" DIA.

No. 240 - Up to 7" RD

No. 241 - Up to 10" RD

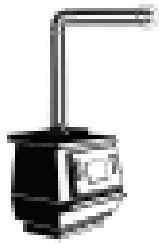

- Available in 5", 6", 7", & 8" Diameters
- 24 Gauge Material
- Heat and Rust Resistant
- Standard Packaging

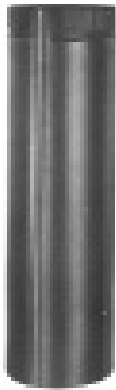

No. BP
SNAPLOCK PIPE
Available 12", 24", & 36" Lengths



No. BP90
90° ADJUSTABLE ELBOW

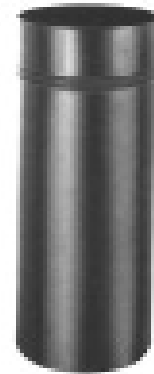

No. BPCHAD
CHIMNEY ADAPTER



No. BP127
OVAL to RD ADAPTER



No. BP54
TEE JOINT



No. BP55
TEE CAP



No. BP58
3 Pc. REDUCER



No. BP96
DRAWBAND



No. BPCON
CONNECTOR



No. BPC
PIPE COLLAR



No. BPTC
TRIM COLLAR

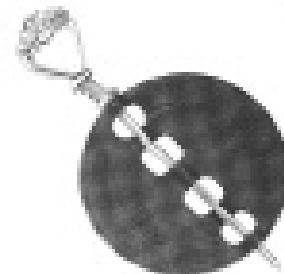

No. CID
CAST IRON DAMPER

Black Pipe, Elbows, & Accessories